

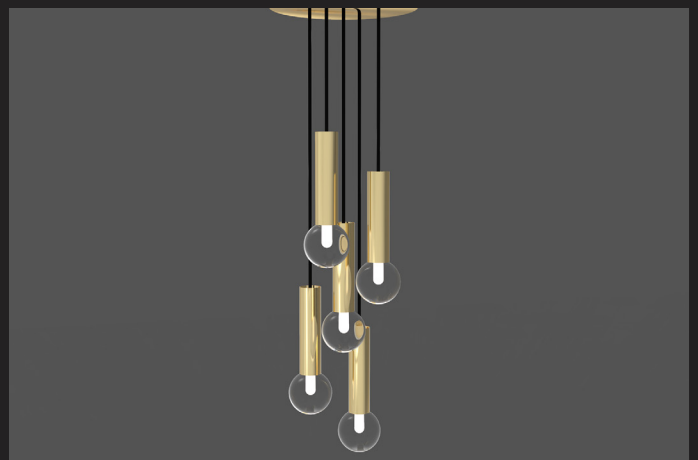

GLOBE PENDANT

Celestial spheres of light.

GLOBE PENDANT (1, 3 & 5)

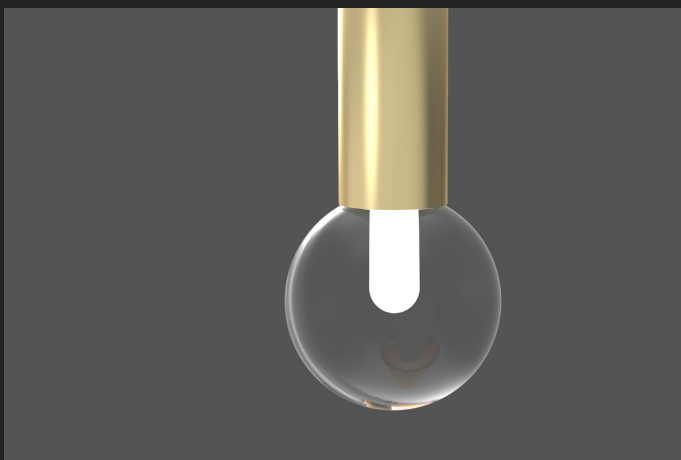
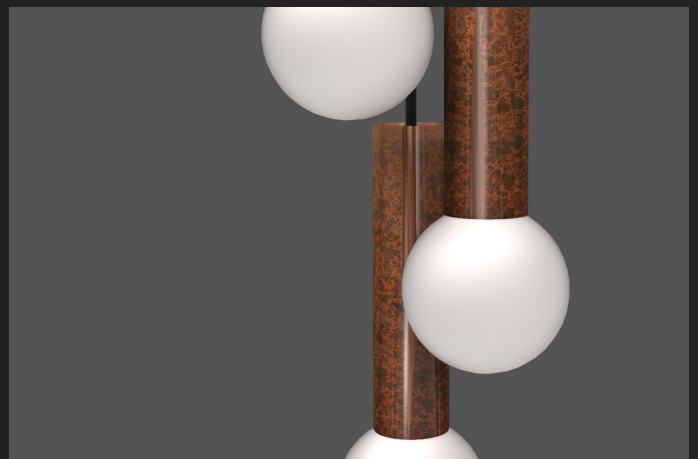
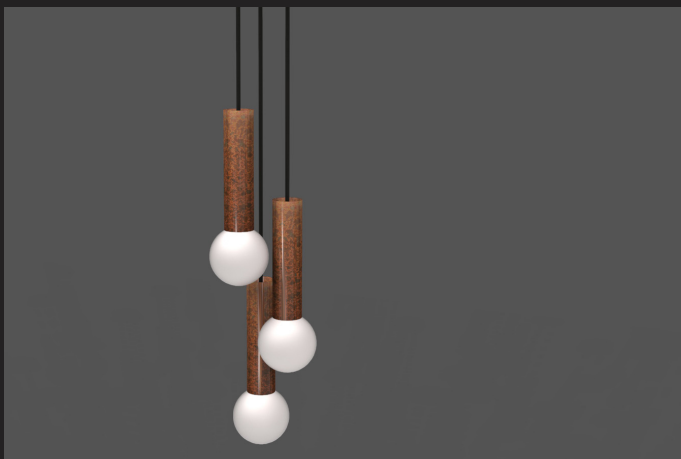
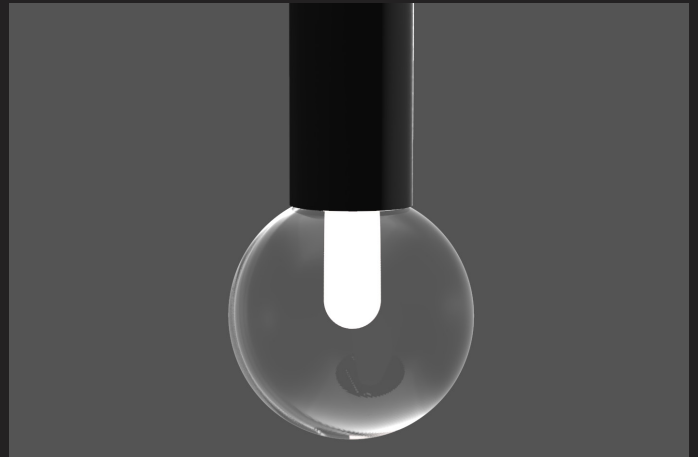

GLOBE PENDANT (1, 3 & 5)

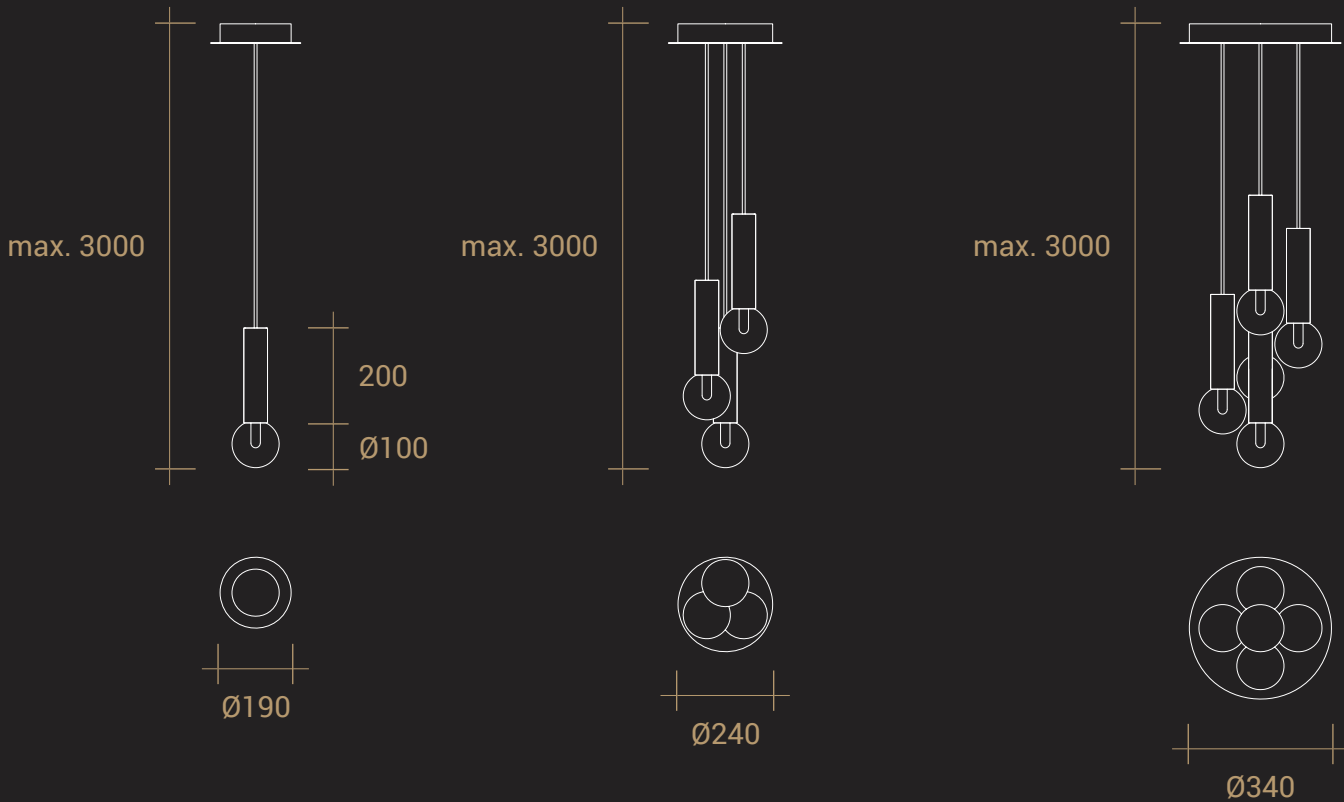

GLOBE PENDANT DIMENSIONS

Ø100 x 200mm tube

LED

Fully replaceable Vossloh LED module

DRIVER

Remote Vossloh driver

MOUNTING

- 1 - Ceiling canopy with Ø150 footprint
- 3 - Ceiling canopy with Ø200 footprint
- 5 - Ceiling canopy with Ø300 footprint

DIMMING

On request - DALI / Phase

LEAD TIME ESTIMATE

4 - 6 weeks

NOTES

- Adjustable heights = multitude of installation configurations
- Solid machined acrylic globe diffuser: impact proof, no shattering glass
- Replace LED module only, globe diffuser lasts for life of product
- Custom finishes available on request

CONTACT

Artefact Industries
artefact@artefactindustries.com
+61 3 7018 3517

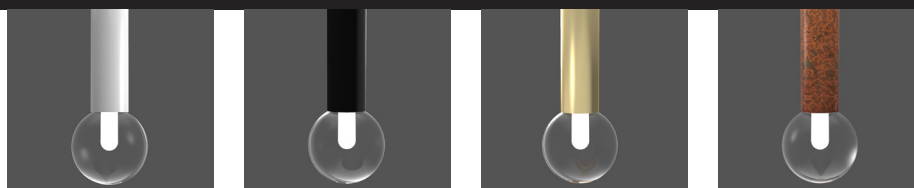
GLB-154
GLB-158
GLB-162
GLB-155
GLB-159
GLB-163
GLB-156
GLB-160
GLB-164
GLB-157
GLB-161
GLB-165

CODE	FINISH	TYPE	SUSPENSION
GLB-154	SHOJI WHITE SATIN	1 - SINGLE GLOBE*	BLACK OR WHITE FLEX. 3000MM L (PER GLOBE)
GLB-155	GLOSS BLACK		BLACK OR WHITE CEILING CANOPY
GLB-156	SOLID BRASS - BRUSHED & CLEAR COAT		CANOPY COVER PLATE IN FINISH TO MATCH GLOBE PENDANT
GLB-157	SOLID COPPER - ROSSO PATINA		
GLB-158	SHOJI WHITE SATIN	3 - THREE GLOBES*	NOTE - EACH FLEX SUSPENSION IS ADJUSTABLE DURING INSTALLATION UP TO A LENGTH OF 3 METRES
GLB-159	GLOSS BLACK		
GLB-160	SOLID BRASS - BRUSHED & CLEAR COAT		
GLB-161	SOLID COPPER - ROSSO PATINA		
GLB-162	SHOJI WHITE SATIN	5 - FIVE GLOBES*	
GLB-163	GLOSS BLACK		
GLB-164	SOLID BRASS - BRUSHED & CLEAR COAT		
GLB-165	SOLID COPPER - ROSSO PATINA		

* Nominate clear or frosted or mixed finish globes when ordering

SPECIFICATIONS

OPTION	POWER	LUMINOUS FLUX
1 - single	1W	130lm*
3 - cluster	3W	390lm*
5 - cluster	5W	650lm*

* Measured at 3000lm, at source

SPECIFICATIONS

CT	CRI	INPUT VOLTAGE	LIFE	IP RATING
3000K	80+	12V / 350mA (Remote driver)	50,000hrs L70/B50	IP20
4500K				

DOWNLOADS

- [↓ Installation, Care & Maintenance Guide](#)
- [↓ Tiny LED Module data sheet](#)
- [↓ Artefact environmental impact statement](#)

DETAILS LISTED IN THIS DOCUMENT ARE SUBJECT TO CHANGE WITHOUT NOTICE . PLEASE GO TO WEBSITE FOR UPDATED INFORMATION